

Digital display

User Manual

Installation Instructions

1. Open the packaging and check that all the accessories are present

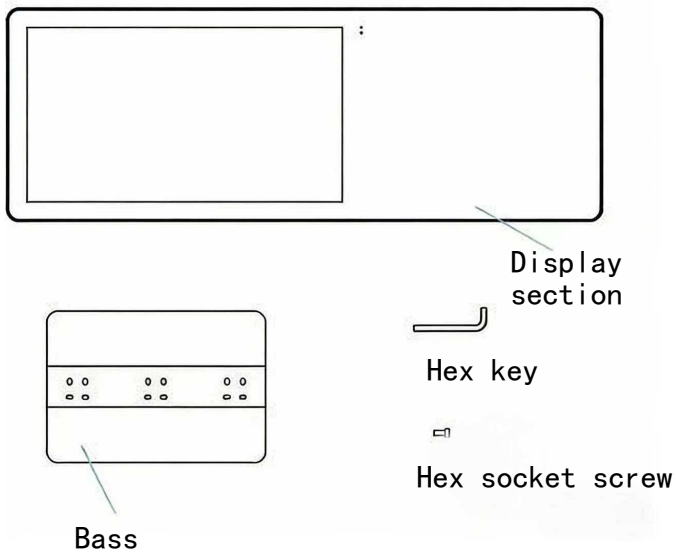

2. Place the LCD panel flat on the desk and use a hex key to secure the base to the display

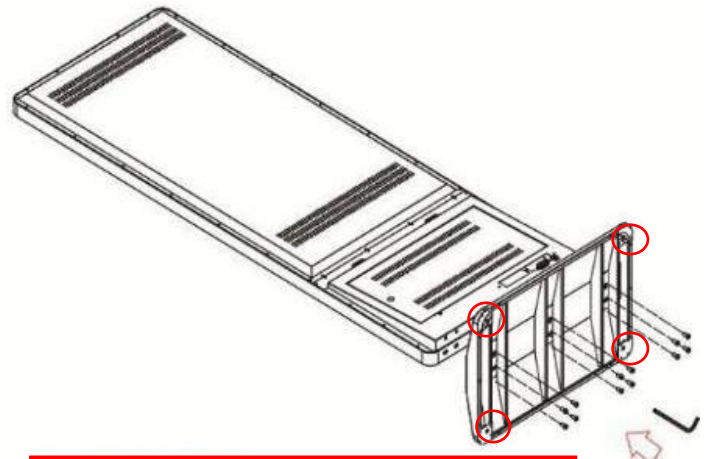

If you need to use wheels, please fit them into these four holes

3. Installation diagram

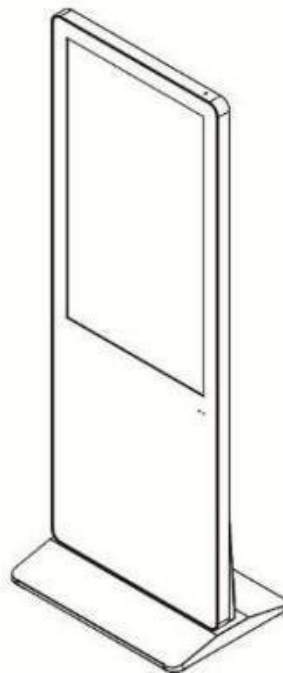

Advertising Display Pre-configuration

When you switch on the advertising display, it will automatically launch the 'Yunbiao IoT Information Distribution System' app. The Yunbiao main screen after launch is shown below. Please check your network connection first. If 'No network (No IP)' is displayed, you will need to configure the network settings as follows.

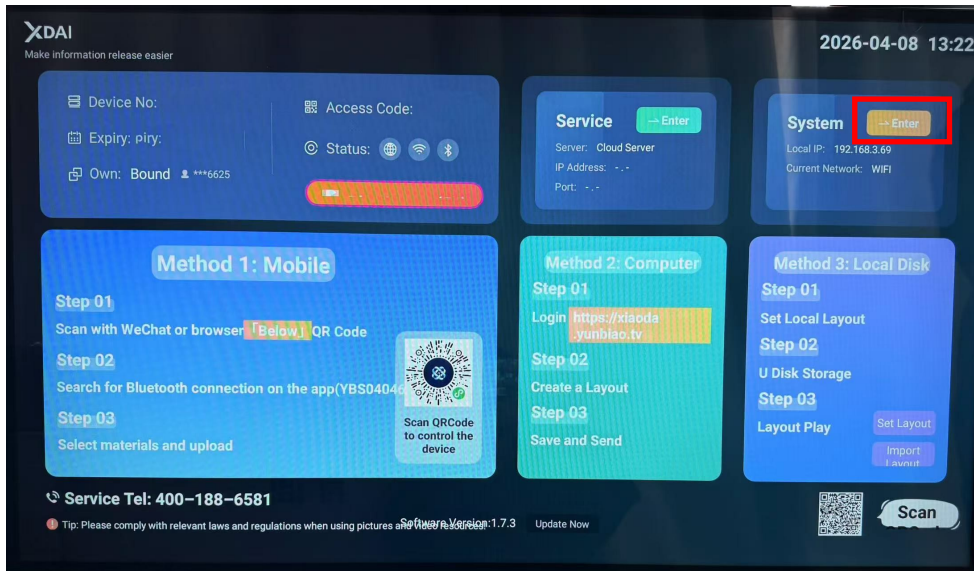

How to use: (1) Wired network connection: Simply plug in the cable and switch on the Ethernet switch. (2) Wi-Fi setup: You can operate the device using a remote control, mouse or smartphone Bluetooth remote control (you will need to scan and log in via the 'Xiaoda Zhixian' mini-programme).

Method 1: Click 'Connect Now' in 'System Settings' in the top-right corner of the screen above to configure your Wi-Fi or Ethernet connection. As shown in the image below, you can bring up the Quick Keyboard whilst connecting and use it in conjunction with the number keys on the remote control.

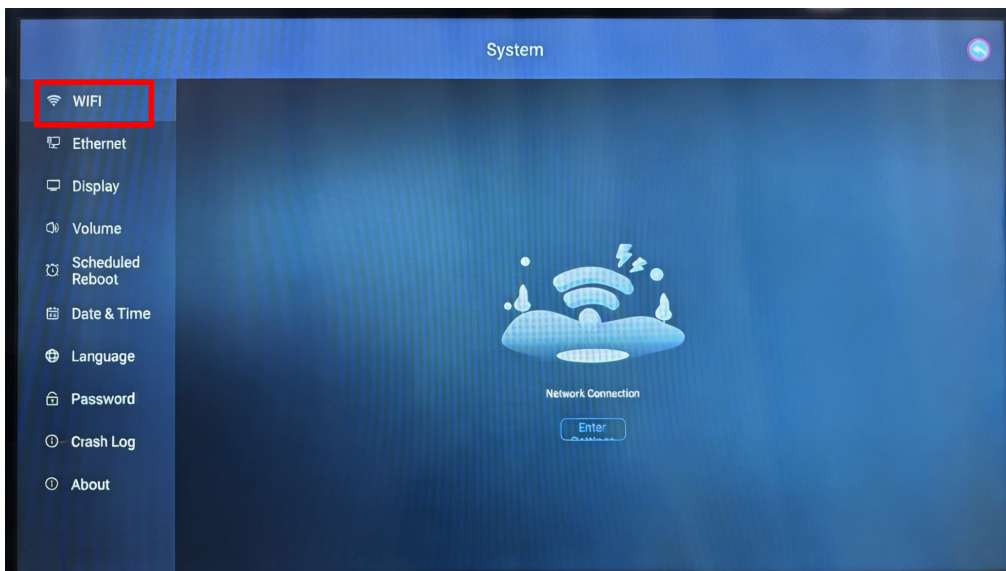

Method 2: First, press the 'Back' button on the remote control to exit to the Android home screen.

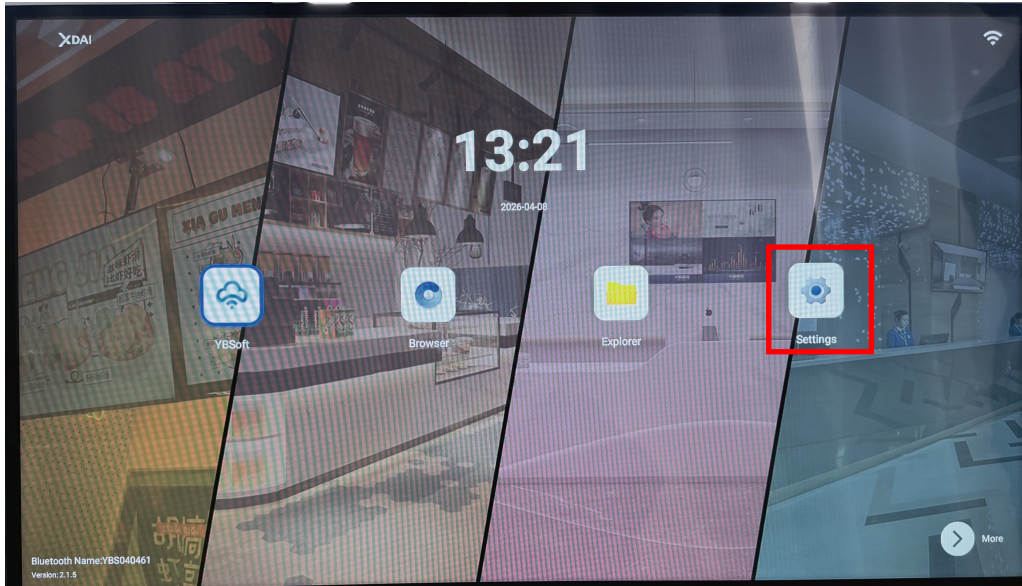

Android System Main Menu Screen

Select 'Settings' (the area highlighted in red in the image above) to open the settings screen, then enable the network and configure the Wi-Fi or Ethernet connection.

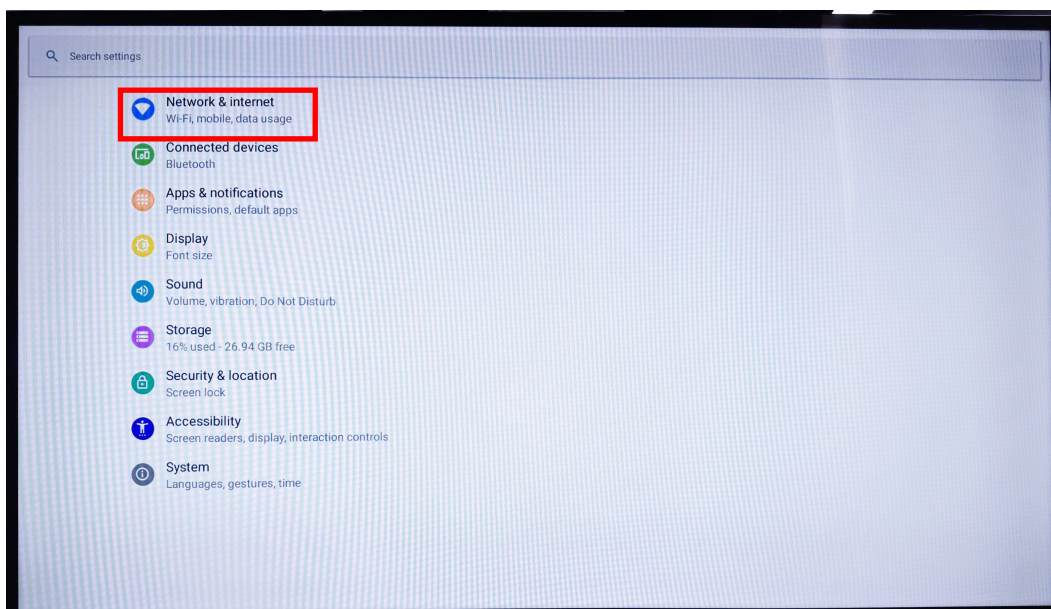

Settings screen